

IT Transformation V100R001C00 Technical White Paper

Issue 01
Date 2014-08-25

Copyright © Huawei Technologies Co., Ltd. 2013. All rights reserved.

No part of this document may be reproduced or transmitted in any form or by any means without prior written consent of Huawei Technologies Co., Ltd.

Trademarks and Permissions



and other Huawei trademarks are trademarks of Huawei Technologies Co., Ltd.

All other trademarks and trade names mentioned in this document are the property of their respective holders.

Notice

The purchased products, services and features are stipulated by the contract made between Huawei and the customer. All or part of the products, services and features described in this document may not be within the purchase scope or the usage scope. Unless otherwise specified in the contract, all statements, information, and recommendations in this document are provided "AS IS" without warranties, guarantees or representations of any kind, either express or implied.

The information in this document is subject to change without notice. Every effort has been made in the preparation of this document to ensure accuracy of the contents, but all statements, information, and recommendations in this document do not constitute a warranty of any kind, express or implied.

Huawei Technologies Co., Ltd.

Address: Huawei Industrial Base
Bantian, Longgang
Shenzhen 518129
People's Republic of China

Website: <http://enterprise.huawei.com>

Contents

1 Background	4
1.1 Overview	4
1.2 Challenges.....	5
1.3 What Is Data Center Transformation	5
1.3.1 Overview.....	5
1.3.2 Key Features	6
2 Introduction to Assessment Service	10
2.1 Purposes.....	10
2.2 Assumptions.....	10
2.3 Methodology	11
2.3.1 Professional Process	11
2.3.2 Professional Tools.....	11
2.4 Implementation	12
2.4.1 Transformation Due Diligence	12
2.4.2 Assessment Service.....	16
2.4.3 Planning Service.....	17
2.5 Deliverables	18
3 Introduction to the Efficiency Assessment Service	20
3.1 Purposes.....	20
3.2 Methodology	20
3.3 Implementation	21
3.3.1 Process	21
3.3.2 Tools	22
3.4 Deliverables	22
4 Introduction to Consolidation Architecture Service	25
4.1 Purposes.....	25
4.2 Implementation	25
4.2.1 Process	25
4.3 Deliverables	26
5 Introduction to the Migration Service.....	27
5.1 Purposes.....	27

5.2 Assumption and Limitation	27
5.2.1 Assumption	27
5.2.2 Limitation.....	28
5.2.3 RACI Matrix	28
5.3 Methodology	29
5.3.1 DC Transformation Methodology.....	29
5.3.2 Planning Service.....	29
5.3.3 Migration Service	29
5.3.4 Migration Implementation	30
5.4 Wave Planning and Design	30
5.4.1 Design Principles.....	30
5.4.2 Assumptions.....	33
5.5 Implementation	34
5.5.1 Planning Service.....	34
5.5.2 Migration Service	35
5.5.3 Process	37
5.5.4 Tools	37
5.5.5 Temporary Infrastructure.....	38
5.6 Verification and Validation.....	38
5.7 Deliverables	39
6 Benefits	40
7 Conclusion	42
8 Why Huawei	43
8.1 Professional Service	43
8.2 End to End Solution.....	43
8.3 Global Delivery	44
8.4 Successful Story	45

1 Background

1.1 Overview

Chief information officers (CIOs) are facing the challenges, that is, to change from cost-centric position to strategic business providers. The expectations are to

- Increase business growth
- Improve agility and flexibility
- Respond quickly to opportunities
- Invest more in innovation

The overall objective is to reduce costs. Organic growth, mergers, acquisitions, globalization, low hardware costs, and demands for cutting-edge consumer and business applications have created an explosion in most companies' technology infrastructures. This accumulation of IT resources is costly and difficult to manage efficiently.

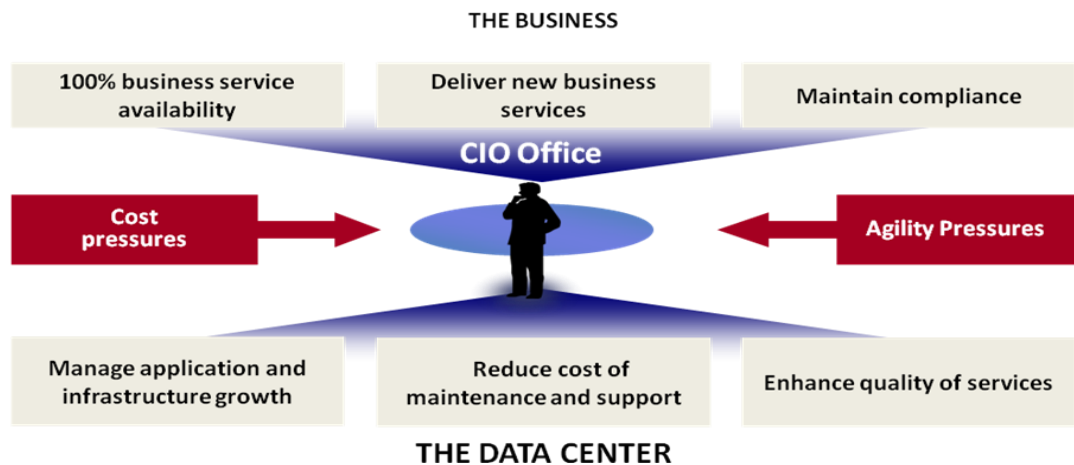

1.2 Challenges

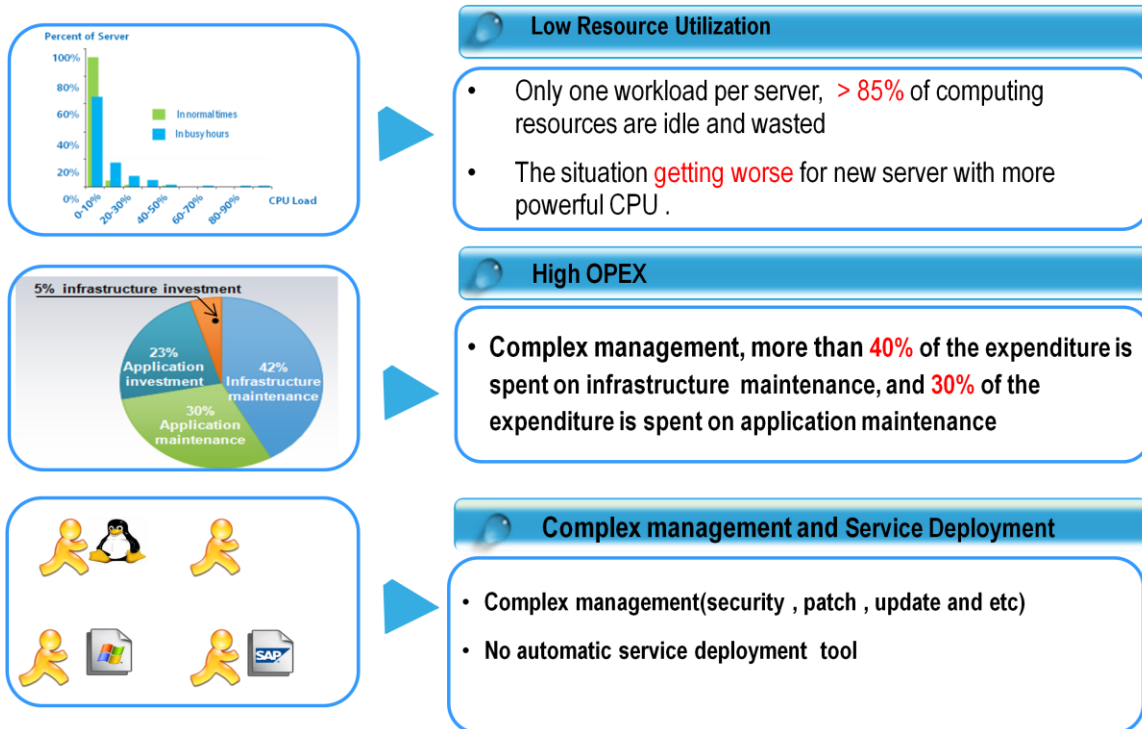

1.3 What Is Data Center Transformation

1.3.1 Overview

Data centers have become a challenging environment for maintenance. A new model for data center operations is required, and customers are finding themselves at the beginning of a journey of transformation for the data center facilities, operations, people, processes, and strategy. This type of transformation requires the ability to take a holistic view of the data center. Vendors with a full portfolio of offerings and partnerships are in the best position to address the unique needs of the data center. Huawei has responded to the needs of its customers by offering a full suite of data center solutions that can address requirements from a simple server consolidation project all the way up to a full data center build out.

Huawei has created key solutions that enable it to collaborate with customers to design and re-architect data centers, leveraging its systems hardware, software, and services offerings.

Huawei DCT Solution and Service

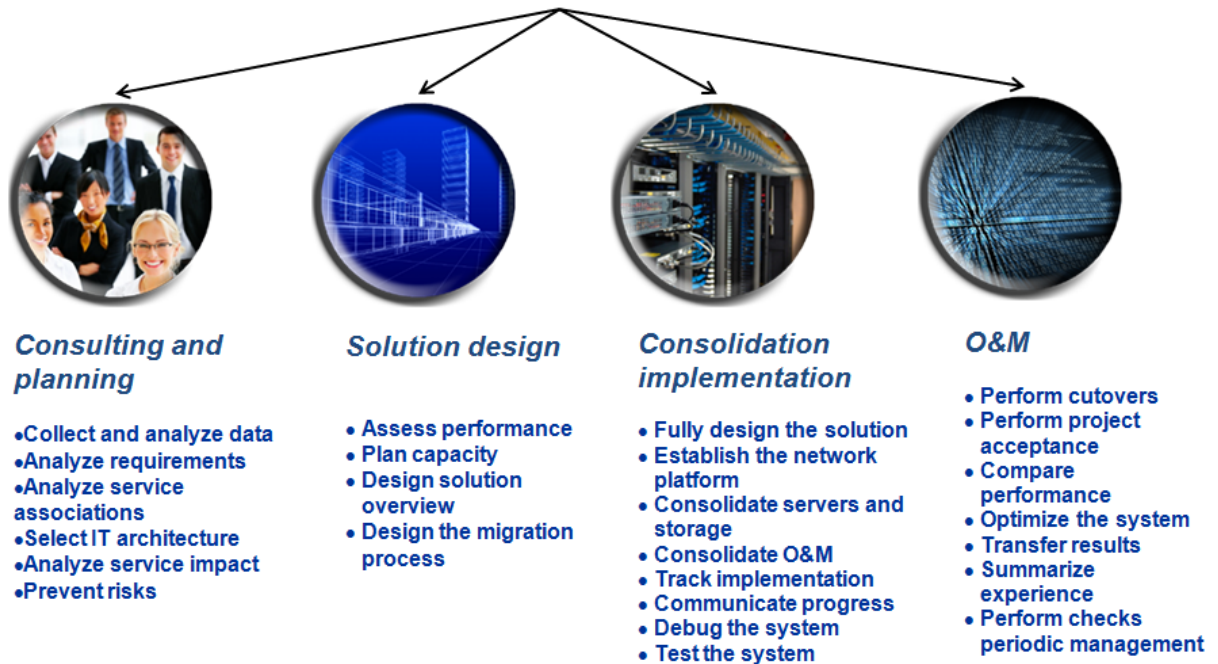

1.3.2 Key Features

1.3.2.1 Assessment Service

Transformation Due Diligence

Due Diligence is a critical phase among the phases of DC transformation. Due Diligence aims to perform a complete study on the present state of the process at the customer side and provide tactical operational input to design the customer "To Be" design process. This phase would also involve capturing and documenting the "As Is" process flows, handoffs, exceptions & metrics, releasing the technology requirement of materials and creating the DC Transformation, Assessment and Effect Analysis.

Assessment Service

Before the migration starts, engineers need to perform many operations to ensure successful migration. Assessment of the existing system structure and resource usage is a must. During assessment, the following information must be obtained through investigation or tools.

- Current system dependency, number of service types, and distribution modes for services on various servers.
- Current physical server resource usage, including the CPU, memory, disk, and network connections. To ensure successful migration from the source to the target, the target must provide at least VM specifications that are the same as the actual physical resource requirement.
- Current physical situations, including whether these physical devices can support virtualization, whether the resources will be expanded, and virtualization will be performed on these physical servers before migration.

- Current storage capacity and resource usage assessment. Storage will be planned in the target system. How the existing storage is adopted? For example, some servers adopt the system volume and data volume on the local server disks, whereas some servers adopt the system volume on local disk but the data volume on SAN/NAS.

Planning Service

After assessment on the existing network situations, the information about existing resource usage, services, and system requirements is clear. The migration plan involves the following steps:

- Determine migration steps, including the server migration sequence, which minimizes the risks.
- Determine the backup solutions based on the systems to be consolidated. Some servers will be reused for virtualization, and the data on these servers will be cleared before virtualization. How to back up the data on these servers to ensure service continuity?
- Prepare and plan the tools used for migration as well as the tool suite function and the network environment for tool usage.
- Plan an additional test environment before migration, which ensures a success migration. The number of servers and storage for this test environment must be planned.
- Plan the network. There are about N data centers in different locations, network connection plan, data duplication between the local and remote sites, network traffic, and network congestion must be taken into consideration.
- Determine the migration period and team members.

1.3.2.2 Migration Service

- End-to-end service
Advisory and design: overall framework, basic internet, computing storage, safety, motor room facility, and management.
Implementation: design the plan, set up internet platform, integrate the operation and maintenance management, follow up the status, progress communication, system integration, and tests.
Business migration: use a series of tools, such as information collection, capacity planning, integration design and migration evaluation method to provide the data and application migration service in the scenarios such as P2V, V2V, and P2P, which ensures smooth business transition.
- Various integration models
A production center + a disaster recovery center
A production center and a complementary disaster recovery center
A main data center + several branch data centers
- S.M.A.R.T
S-Simple: simple framework, simple management, simple to expand and use. (The double-layer net framework is used to provide the unified management system.)
M-Manageable: unified multi-DC management, automatic business deployment, light weight management platform, and enhanced management platform. (Functions of unified management system can be customized.)
A-Agile: easy to change and manage.

R-Reliable: reliable equipment, mature software, framework redundancy disaster recovery and backup, active prewarning (unified supervisory and redundancy configuration)

T-Trust: data encryption, security isolation, open compliance, authorized access, and modular E2E safety programs.

2 Introduction to Assessment Service

2.1 Purposes

The primary objective for DC Transformation and Assessment Service is to

- Analyze the data center installed based on physical and virtual server technologies,
- Analyze the data center about the current storage technologies
- Analyze the data center about the current database technologies
- Look for opportunities for further consolidation, virtualized server, database and storage environment with lower cost and higher efficiency.

The DC Transformation and Assessment Service is based upon the analysis of performance, configuration, business dependencies, and fiscal expenses associated with continued use of the current data center environment.

2.2 Assumptions

During DC transformation, the following migration scenarios must be considered:

- Data collection: During this process, Huawei DC transformation service uses agent or agent-less method to collect data from existing environment. This activity requires customer to open defined ports and grant security permission.
- Configuration: The location of the storage and servers will be changed from one location to another. How to restore the configuration if it is modified during the migration? For example, how to restore the network cable connections and switch configurations, including the IP addresses?
- Data: New storage products with larger capacity and performance are introduced during consolidation. How to migrate data from one storage device to the new storage products.
- Virtual machine (VM): New virtualization technology is adopted for host consolidation in new data centers. How to perform the migration from physical hosts to VMs (P2V)?
- Applications: Some file-level migration tools are used to migrate the applications from legacy hosts to the new physical or virtual systems in the data center, which affects little to these applications.

Many applications in existing environment are layer-3 applications. It is recommended that migration starts from web server to the DB server based on the importance and dependency of these applications. The following assumptions must be complied:

- Migrate the X86 architecture applications to the physical environment or virtual environment.
- Migrate the Oracle database from RISC or X 86 to X86 physical environment.
- Migrate the data from old storage environment to the new one.

2.3 Methodology

2.3.1 Professional Process

5 Steps in the assessment service:

Step 1- Assessment Workshop

Introduce the assessment service methodology and process by a workshop.

Step 2- Information Collection

Collect the DC information (configuration information, performance information, application architecture, business information and etc.) by some professional tools.

Step 3- Analyze

Analysis the current DC environment, from IT architecture, L1 level information, application information, business requirement and etc.

Step 4- DC assessment

Give the current DC assessments which include server consolidation, storage consolidation, capacity planning, resource reuse and etc.

Step 5- Suggestion

After the DC assessment, some suggestion would be given about the further DC building.

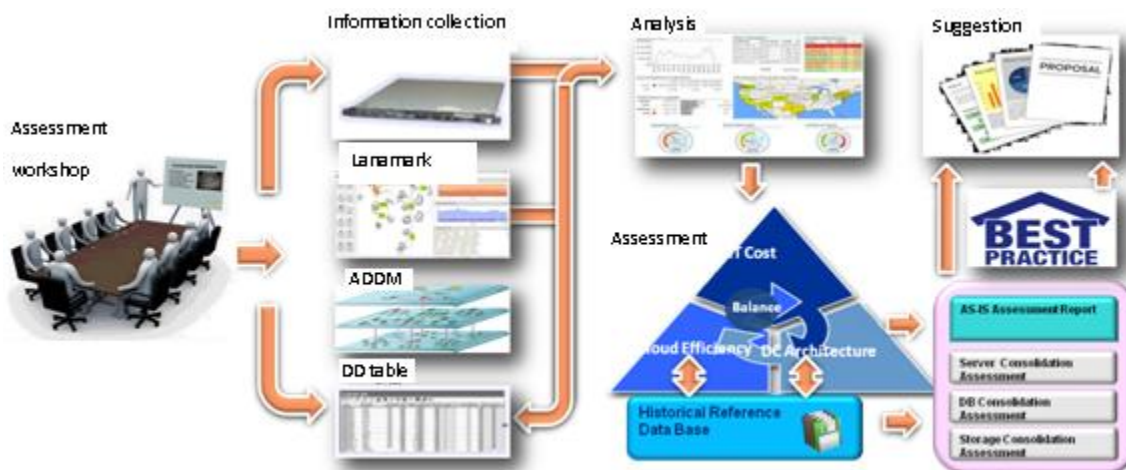

2.3.2 Professional Tools

Huawei provides some tools to enhance the efficiency about Step 2- Information collection.

Tools	Use for
Lanamark	Server configuration information and performance information collection; Capacity planning.
ADDM	server configuration information collection; Application configuration information collection; Application relationship information collection.
Opstor	Storage configuration information collection; Network configuration information collection.

2.4 Implementation

2.4.1 Transformation Due Diligence

Due Diligence Objectives

Due Diligence provides a business framework that will allow Huawei and customers to reach a definitive agreement based on requested or provided information and/or a set of key assumptions with the ability of both parties to mitigate risks. The primary purpose of due diligence is to eliminate assumptions and replace them with facts, document risks and their mitigation plans or the effect on the solution and list the issues and dependencies of the deal.

The Due Diligence process allows Huawei to build a clear picture in scope processes, staff and costs of the telecommunications operator, in particular:

- **Verify Facts and Assumptions:** Verify the facts and confirm assumptions that could have a material effect on the cost, solution, and/or contract agreement.
- **Discover Improprieties:** Discover improprieties in a data center IT organization information.
- **Discover and Measure Risk:** Discover and measure risks is an important part of reviewing information. This process is used to determine how to understand risks and how they mitigate risky situations. This will in turn strengthen the relationship with customers.
- **Confirm Expectations and Commitment:** Confirm assumptions related to the ability of all parties involved in the deal to deliver on their commitments.

Due Diligence Scope

The DD scope includes but not limited to the following:

- Business (product, service, and SLA)
- IT operation management (organization, process, and tools)
- Application
- IT infrastructure
- IT asset
- Disaster and recovery

Due Diligence Approach

Due diligence refers to a range of functional activities, each focusing on the objectives of validating assumptions but in various business areas. Our approach to due diligence is to manage various critical activities under a project governance.

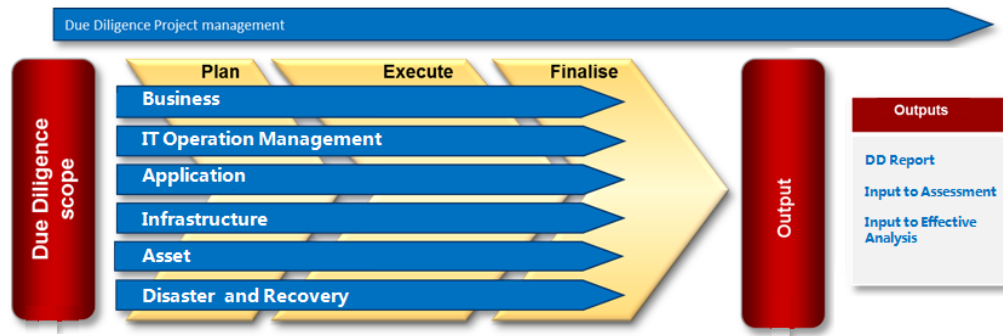

The due diligence project has three phases and multiple streams to conduct due diligence. The scope and input for the due diligence is derived from the proposal and output of the due diligence is used to influence changes in final contract if required.

Due Diligence involves three steps.

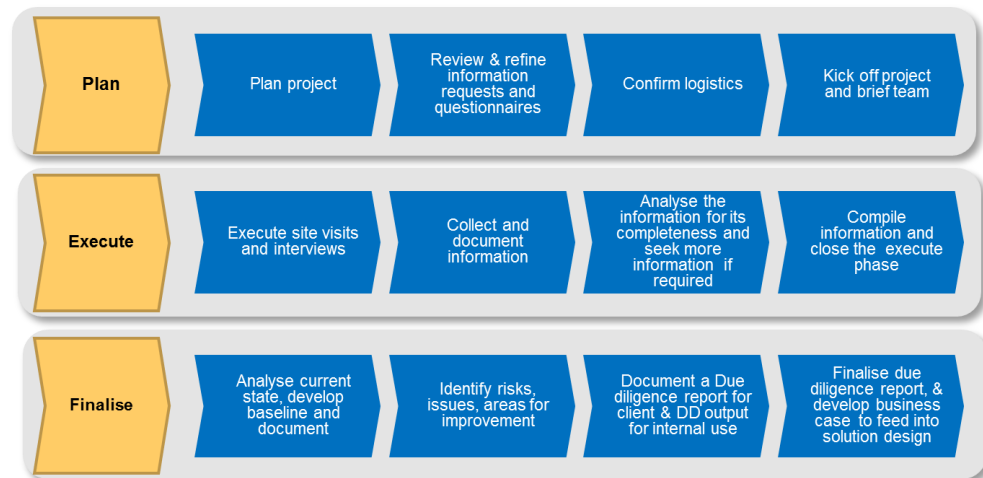

- **Plan Due Diligence**

Planning phase involves ensuring that all the planning and preparations have been made before the team begins to the actual exercise.

This stage includes predominantly planning the due diligence project including confirming the scope, developing work plan/schedule, planning resources, refining the information requirements for due diligence and finally kick off the project.

- **Execute Due Diligence**

The execute phase of the due diligence is very critical and comprises two critical aspects of Due Diligence: Collect information and Analysis information.

Collected information is analyzed at a high level to validate the completeness and clarity, in case of any gaps more information is sought. Hence the execute phase of due diligence has a loop, unless we are satisfied with the collected information.

The execution phase includes the site visit, interviewing people and initial analysis of information for its completeness.

- **Finalize Due Diligence**

This is final stage of Due Diligence and the collected information is used to analyze the current state and develop base line so that the collected information can be used for the reason it was collected in the first instance.

2.4.2 Assessment Service

Environment Preparation

Huawei DC Transformation solution is a data-driven process. To provide rich and accurate data for analysis process, Huawei will use data collection appliance and DD forms to collect data. This will make analysis process quick and effective.

Data Acquisition

- What to gather

Configuration Data

Through flexible rules-driven analysis, Huawei analyzes deep hardware, OS, application, middleware and database configuration data so technical fit is accurately assessed. Data collection for configuration constraints for the purposes of this workshop will be facilitated through WMI scripts.

Utilization Data

It is critical that utilization analysis goes beyond a comparison of peak utilization and server capacities. Huawei considers peak and sustained activity as well as the nature of workload patterns and personalities to accurately determine what fits together. Complementing its rules-based analysis, Huawei offers powerful utilization analysis to accurately model workloads enabling organizations to achieve an optimal balance between risk, service levels, and consolidation ratios. Data usage will be collected and imported into Huawei.

Business Constraints

Huawei editable rules factor in a variety of business related constraints including regulatory requirements, maintenance windows, geography, service levels, and other key considerations into the analysis of whether applications or content should reside on the same server. For the purposes of this workshop three business constraints will be collected. These are location, department, and environment. A .csv file named Attributes.csv for collecting these business constraints has been provided as part of this package.

- How to gather

Huawei provides flexible data acquisition options including:

- Huawei DD procedure can help DC transformation project to collect business, IT operation, application, infrastructure, asset and DR data to help transformation analysis.
- Huawei native data collection options such as scripts, agent-less capabilities or read-only agents.
- Import data from third-party monitoring or management systems to avoid duplicating data collection activities for utilization or configuration details.

Data Analysis

- Analysis Overview

The subtleties associated with the proper operation of an IT environment typically manifest themselves in the form of constraints. Many of these are intuitive, and include things such as "that application does not run on that OS", "the servers from different locations cannot go on a single box" or "those applications will not fit together on the

target system". But others can be far more complex, dealing with obscure configuration variations, abstract business requirements and detailed utilization patterns.

- **Key Considerations**

These constraints can be organized into three fairly intuitive categories: technical, business and workload. These are collectively referred to as the three pillars of transformational analysis, and in simple terms they seek to answer the following questions:

- What can go together?
- What should go together?
- What fits together?

Looking at all three areas is critical in modern IT environments, particularly for production servers, which are often laden with constraints related to how they operate and how they are managed.

- **Analysis Perspectives**

Huawei DC Transformation solution analyzes the migration data through the following three perspectives:

Technical Constraint Analysis

- Server analysis
- Storage analysis
- Network analysis

Business Constraint Analysis

- Business constraints
- Process constraints
- Security constraints

Workload Constraint Analysis

- CPU analysis
- Memory analysis
- Disk analysis
- Network analysis
- Aggregate utilization analysis
- Power consumption analysis

Integrated Analysis

- Integrated analysis

2.4.3 Planning Service

Migration Planning

Huawei provides the most comprehensive transformation and migration planning solution in the market. In kinds of complex IT environment, Huawei can provide the analysis to ensure that your movement is made faster, with less risk and cost. Huawei not only provides you with detailed information regarding infrastructure requirements, but also provides detailed

placement and guest sizing information so the resulting environment is optimized from every perspective.

Major migration planning is described as follows:

- Plan movement groups or waves to ensure migration is executed with a view to application dependencies.
- Qualify and profile workload candidates to determine the proper migration to the cloud.
- Normalization of workloads leveraging benchmarks for accurate analysis.
- Size workloads and assessing workload history, patterns and profiles.
- Investigating opportunities across multiple hardware brands or even platform architectures.
- Determining precise infrastructure requirements to avoid over-provisioning.
- Analyze power consumption and potential savings.
- Policy modeling, such as SLA requirements, privacy, security, DR, HA policies, regulations, and utilization limits.
- Determine the best match with suitable environments, cloud instance sizes and software stacks based on existing configurations, migration policies and costs.
- Exception handling for workloads that are not suitable for migration or do not match standard cloud offerings.
- Determine specific workload placement and resource allocation requirements.
- Enable automatic placement through the generation of machine-readable extracts that feed provisioning tools.

Risk Mitigation Plan

- Matrix of identified risks, symptoms, and impacts associated with migration efforts, prioritized based on the associated impact
- Scheduling analysis including conflicts at the application and application group level along with resolution options
- Risk Mitigation Options ranked by Risk Factor and associated impact
- Network and application vulnerability assessment and remediation reports

Runbook Validation and Contingency Planning

Huawei will develop Runbooks and contingency plans. The scope of this step is to validate the completeness and effectiveness of the Runbooks, ensure all parties agree and understand their roles, hand offs, and then verify that the contingency plans are sufficient in scope and detail, and agreed with all parties.

2.5 Deliverables

The major DC assessment service deliverables include:

Due Diligence

- Due Diligence Report

Assessment Service Deliverables

- Current System Top Architecture

- Configuration Information Reports (Refer to manual collection Excel sheets)
- Application Information Reports
- Workload Information Reports
- Business Information Reports
- Technical Constraint Analysis
- Business Constraint Analysis
- Workload Constraint Analysis
- Integrated Analysis

Planning Service Deliverables

- Migration Planning
- Capacity Design
- Assets reuse Design
- Risk Migration Management Plan

3 Introduction to the Efficiency Assessment Service

3.1 Purposes

To meet the requirements on investment estimation and analysis and support enterprise management teams making the decisions on DC transformation project planning and implementation, more and more customers have decided to get a comprehensive efficiency assessment on the current DC and the target DC. This helps them consolidate or build a low power consumption, high resource utilization, high return on investment (ROI), and high efficiency target DC.

The objectives for the efficiency assessment service are as follows:

- Differentiate investment in traditional DC and target DC
The comprehensive cost analysis on infrastructure, including server, storage, network and other relative cost analysis, helps customer differentiate the cost analysis result between their current traditional DC and target efficiency DC.
- Differentiate the efficiency result in current traditional DC and target DC
The efficiency analysis on DC power energy, IT resource utilization and IT management utilization, differentiates the efficiency result between their current traditional DC and target efficiency DC.
- Differentiate business continuity statement of current traditional DC and target DC.
- Provide next step recommendation for customers based on the comprehensive DC efficiency analysis result.

3.2 Methodology

Huawei Data Center Transformation Efficiency Assessment service is based on Huawei Data Center Transformation and DC solution best practices. The service includes the green DC design principle and plenty of cloud DC project experiences.

The assessment will adopt Huawei DC Transformation Efficiency Assessment tool, in conjunction with Huawei DC transformation and solution expert analysis. Based on the pre-requirement information, the Efficiency Assessment tool engine processes the information, and provides the detailed analysis result. Then, the transformation expert team completes the

last overall assessment report and provides next-step recommendation for customers based on target DC technologies and the tool-processed detailed analysis.

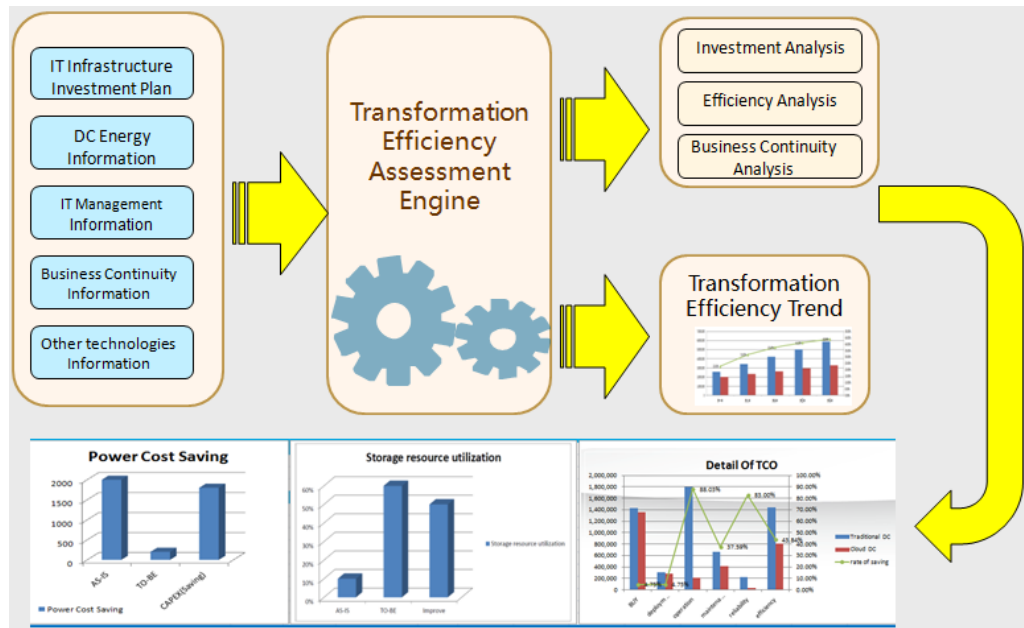

3.3 Implementation

3.3.1 Process

Step 1 Data gathering

Huawei provides flexible data acquisition options including:

- Huawei DD procedure can help DC transformation project to collect business, IT operation, application, infrastructure, asset and DR data to help analysis.

Step 2 Data Analysis

The DC transformation efficiency assessment service will complete analysis on multiple DC-related items and compare customer legacy DC with target consolidated DC.

The highlights of the DC transformation efficiency assessment include:

- Business continuity analysis
 - System optimization assessment
 - Security strengthening
 - Data protection and business continuity analysis
 - Disaster recovery assessment
 - DC architecture modernization
- Efficiency analysis
 - PUE & energy assessment
 - IT resource utilization assessment
 - IT management efficiency assessment
 - TTM

- Cost assessment analysis
 - Computing virtualization
 - Storage
 - Network and security
 - Facility, cooling, and power
 - Space
 - IT service desk cost reduction

Step 3 Report

3.3.2 Tools

The following table will show us most of the tools.

Type	Tools	Usage
Data gathering	DD table	information collection
Data Analysis	EA-Tools	efficiency assessment tools

3.4 Deliverables

In the Data Center Transformation Efficiency Assessment service, Huawei DC transformation team will complete analysis on multiple DC-related items and compare customer legacy DC with the target consolidated DC. The deliverable material is the *Transformation Efficiency Assessment Report*.

The report includes the cost analysis, efficiency analysis, business continuity analysis and next-step recommendation for customers.

The following figures are some snapshots of sample assessment report.

This report is generated, using a Huawei product called Efficiency Assessment. Huawei Efficiency Assessment is available to partners to provide quick and accurate virtualization analysis for end customers. The report generated is a plan based on the customer's specific environment and goes beyond the results that an interview process can provide.

CAPEX (Saving)

IT infrastructure part	AS-IS	TO-BE	Cost (Saving)
Power Cost Saving	5079	802	4277
Cabinet Space Cost Saving	2570	846	1724
Hardware Investment Cost Saving	21300000	6030000	15270000
Administration Staff cost	600000	128000	472000
Server resource utilization(average)	10%	80%	70%
Storage resource utilization	10%	60%	50%
Storage device number	6	1	5
Storage Power Cost Saving	39500	1000	38500
Storage Cost Saving	1300000	30000	1270000

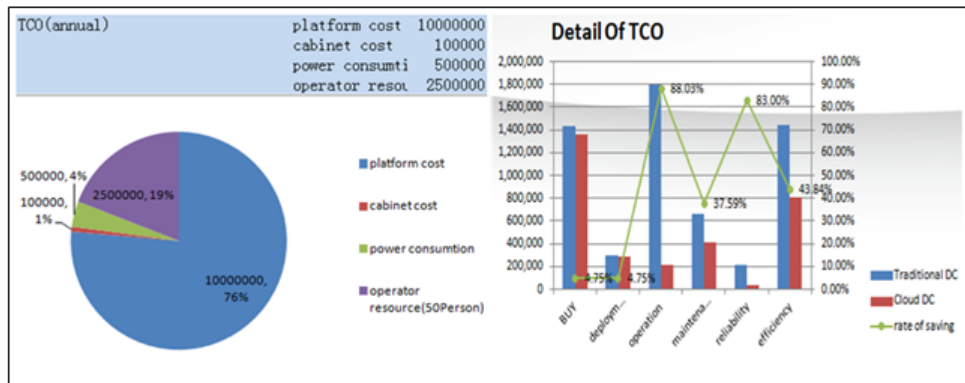

After server virtualization technology implementation, server hardware investment cost is reduced, the following figure shows the server hardware investment saving analysis, each virtualization scenario has different rules for analysis; the virtualization ratio is based on the project best practice. The rules can affect any of the numbers in the tables. These numbers are specific to this scenario and can be compared to other scenarios to determine the optimum configuration.

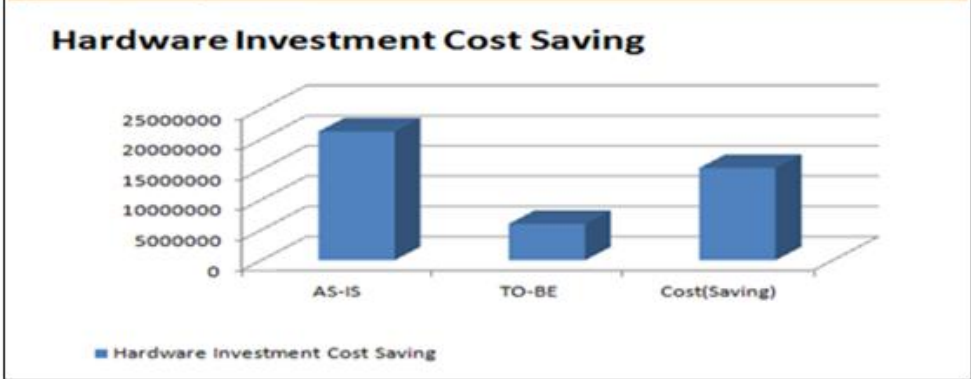

4 Introduction to Consolidation Architecture Service

4.1 Purposes

Provides Consulting about multiple data centers structure evolution strategy. Network, virtual platform, computing & storage convergence solution, IT management, DR&BR, and VDC will be considered in the TO-BE structure.

4.2 Implementation

4.2.1 Process

Step 1 Data gathering or finish the assessment service

Huawei provides flexible data acquisition options including:

- Huawei DD procedure can help DC transformation project to collect business, IT operation, application, infrastructure, asset and DR data to help analysis.

Step 2 Architecture design

- Network structure design
 - Network platform critical requirements
 - Overall network architecture design
 - Data center network core area design
 - Data centers networking design
- Virtualization platform design
 - Virtualization platform requirements
 - Virtualization platform design principles
 - Virtualization platform architecture design
 - Virtualization resource pool design
 - Virtualization high availability design
- Computing & Storage convergence solution design
 - Computing & Storage requirement

- Computing & Storage design principles
- Computing & Storage architecture design
- Computing & Storage model selection
- Computing & Storage resource pool design
- Computing & Storage high availability design
- IT management platform design
- Overview of the IT management platform solution
- Cloud service management solution design
- Operation and maintenance management solution design
- IT service management solution design
- Unified management solution design
- DR & BR design
- DR & BR requirement
- DR & BR design principles
- DR solution design
- BR solution design
- VDC design
- VDC resource management

Step 3 Report

4.3 Deliverables

The major DC consolidation architecture service deliverables include

Proposal

- IT infrastructure consolidation proposal
- IT integration architecture evolution strategy

5 Introduction to the Migration Service

5.1 Purposes

The activities help customer:

- Successfully complete consolidation and migration, leveraging best practices and Huawei extensive experience.
- Execute the migration plan with minimum risks for continued business operations.

5.2 Assumption and Limitation

5.2.1 Assumption

During DC transformation, the following migration scenarios must be considered:

- Configuration: The location of the storage and servers will be changed from one location to another. How to restore the configuration if it is modified during the migration? For example, how to restore the network cable connections and switch configurations, including the IP addresses?
- Data: New storage products with larger capacity and performance are introduced during consolidation. How to migrate data from one storage device to the new storage products.
- Virtual machine (VM): New virtualization technology is adopted for host consolidation in new data centers. How to perform the migration from physical hosts to VMs (P2V)?
- Applications: Some file-level migration tools are used to migrate the applications from legacy hosts to the new physical or virtual systems in the data center, which affects little to these applications.

Many applications in existing environment are layer-3 applications. It is recommended that migration starts from web server to the DB server based on the importance and dependency of these applications. The following assumptions must be complied:

- Migrate the X86 architecture applications to the **physical environment** or virtual environment.
- For the non-X86 architecture applications, database can be migrated from RISC to X86. The databases are deployed on X86 architecture and then synchronous data.

5.2.2 Limitation

This document describes workload migration between same structures, such as from X86 to X86 and database migration between same or different structures, such as from UNIX to X86, or X86 to X86.

The migration details are as follows:

- Workload (Server)

From X86 to X86

- P2P (to HUAWEI physical server)
- P2V (to HUAWEI virtualization platform)
- V2V (other virtualization platform to HUAWEI virtualization platform)
- DB
 - Oracle
- Storage
 - Migration storage arrays to Huawei storage

5.2.3 RACI Matrix

The responsible, accountable, consulted and informed (RACI) matrix is used to define responsibilities.

Project Phase	Step	Huawei	Customer
Survey & assessment	Information collection	R and A	I
	Relevance analysis	R and A	I
	Consolidation assessment	R and A	C and I
	Risk analysis	R and A	I
Planning & design	Strategy developing	R and A	C and I
	Solution developing	R and A	C
	Risk mitigation plan	R and A	C and I
	Project plan & labor division	R and A	C and I
	RunBook	R and A	I
Implementation	Migration rehearsal	R	A and I
	Environment preparation	C and I	R and A
	Migration delivery	C and I	R and A
Assurance & optimization	Monitoring	R and A	I
	Assessment	R and A	A and I
	Optimization	R and A	A
Acceptance	Acceptance request	C and I	R and A

Project Phase	Step	Huawei	Customer
	Acceptance preparation	R and I	C
	Assessment and acceptance	C and I	R and A
	Wave summary	R and A	C and I

 **NOTE**

Responsible: Those who do work to achieve the task. The role of Responsible includes Support, which is to provide resources to complete the task.

Accountable: Those who are ultimately accountable to the correct and thorough completion of the task.

Consulted: Those whose opinions are sought. Two-way communication.

Informed: Those who are kept up-to-date on progress. One-way communication.

5.3 Methodology

5.3.1 DC Transformation Methodology

How to ensure the service continuity and reduce the downtime is a very important issue during DC virtualization and consolidation. There are a lots of physical servers and many kinds of services on the existing system. A step by step methodology is important to ensure successful migration.

5.3.2 Planning Service

After assessment on the existing network situations, the information about existing resource usage, services, and system requirements is clear. The migration plan involves the following steps:

- Determine migration steps, including the server migration sequence, which minimizes the risks.
- Determine the backup solutions based on the systems to be consolidated. Some servers will be reused for virtualization, and the data on these servers will be cleared before virtualization. How to back up the data on these servers to ensure service continuity
- Prepare and plan the tools used for migration as well as the tool suite function and the network environment for tool usage.
- Plan an additional test environment before migration, which ensures a success migration. The number of servers and storage for this test environment must be planned.
- Plan the network. There are about N data centers in different locations, network connection plan, data duplication between the local and remote sites, network traffic, and network congestion must be taken into consideration.
- Determine the migration period and team members.

5.3.3 Migration Service

During this process, batches of servers will be migrated to the new environment, and the following actions are performed:

- Ensure that the entire network is ready for batch migration, and the connection among the migration tools, source system, and target system is proper.
- Check the performance and perform health check for the migrated system. If the system runs properly, disable the legacy system and redirect the service to the new system.
- Reuse hardware and expand software resources, such as memory and disks. These components form the final virtualization infrastructure, also called the final system.
- Reuse or expand the legacy hardware from the source DC to the target DC.

5.3.4 Migration Implementation

During this process, batches of servers will be migrated to the new DC, and the following actions are performed:

- Ensure that the entire network is ready for batch migration, and the connection among the migration tools, source system, and target system is proper.
- Check the performance and perform health check for the migrated system. If the system runs properly, disable the legacy system and redirect the service to the new system.
- Reuse hardware and expand software resources, such as memory and disks. These components form the final virtualization infrastructure, also called the final system.
- Reuse or expand the legacy hardware from the source DC to the target DC.

5.4 Wave Planning and Design

5.4.1 Design Principles

Overview

- Application criticality is evaluated to ensure that critical applications are distributed throughout the waves to reduce risks.
- Migration complexity, which is a measurement calculated based on the number of applications and their interdependencies, including the local core network dependencies, is evaluated to properly distribute applications.
- Application availability and tolerance downtime are considered during best migration method determination. The business priority and legal limitation of applications will also be considered.
- Application interdependency is required to minimize the performance impact and functionality on an application while its dependent application is removed.

Principles

The following diagram shows the overall concept of the wave design.

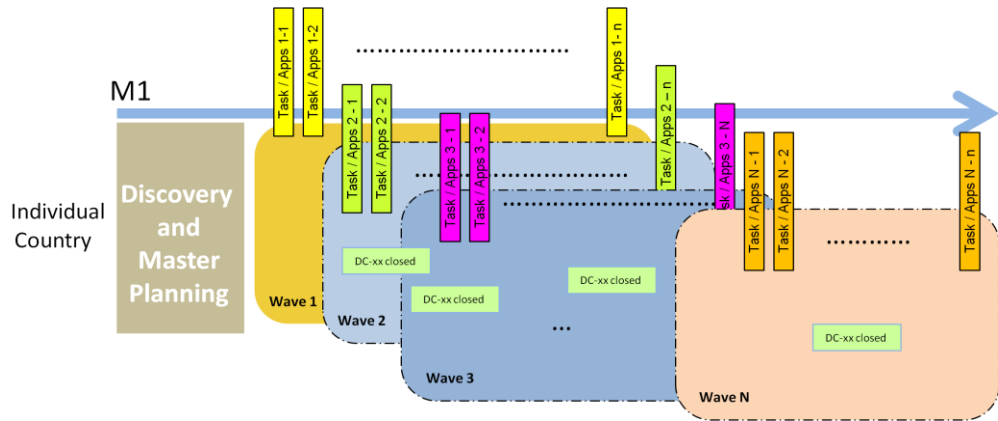

Table 5-1 General principles of the wave design

General Principles	
1	All DCs are involved in each wave. In each wave, applications are selected based on synergistic impacts, risk control, cost control as well as some external non-technical factors, such as data center decommission, and legal and support issues.
2	Waves N and N+1 will be overlapped in time to shorten the overall project time.
3	Each wave (Wave N) has its sub-waves (Wave-xx-N) that are working independently but being centrally controlled. For details, refer to the subsequent sections.
4	Each wave has its applications or tasks to be migrated or completed.
5	The durations of waves are not the same.
6	For each wave, P2P, P2V, and V2V are used based on the application characteristics and criticalities, and customer preferences and limitation.

In addition to the preceding general principles, the following selection criteria that are formulated as the basic design of each wave are described:

- General principles of application selection sequence
- Wave-01 application selection principles
- Wave-X application selection principles

Once Wave-01 and Wave-X of each DC are defined, all other applications will be subsequently arranged between Wave-01 and Wave-X according to the same principles.

Table 5-2 General principles of application selection sequence

Item	Description
1	The wave must ensure minimum service interruption.
2	The migration schedule must align to/before the decommission time of the data centers in each DC.

Item	Description
3	Synergistic effect in migrating same types of applications in different DCs is provided.
4	To minimize risks, waves will be started with non-business critical applications followed by less business critical applications.
5	Within each sub-wave of each country, the maximum number of applications cannot be larger than 100 (for low/medium types) and 50 (for high/iceberg types) so as to mitigate migration risks.
6	In order to enable customers to be gradually familiar with the transformation, Wave-01 for each DC will select 50 low-type critical applications to start with.
7	As the critical system is the bread and butter for operators (such as huge systems running on UNIX and requiring P2P), it is recommended to migrate from the last wave or the wave that is closed to the last wave if it is required to relocate. Note that further review is required for the relocation possibility.
8	The OSS (such as service assurance) type of applications are tightly coupled with the telecom networks. Therefore, a further review for the relocation possibility is required, especially the relocation out of the DC.
9	Systems that have interdependent relationships are moved together in the same wave.
10	If applications in the data center can be removed concurrently so as to speed up the data center decommission, the priority of this wave is higher.

Table 5-3 Wave-01 application selection principles (Wave-XX-01):

Item	Description
1	Non-business critical applications (the complexity is either simple or low) with no other application dependence.
2	Non-billing, non-OSS, non-sales & services and non-infrastructure related.
3	Applications are deployed in data centers that will be closed down soon.
4	Systems that are to be decommissioned. Further verification of the interdependence will be performed first.
5	No political or legal issues for the application migration.
6	Simplified setup process and lowest risk, similar types of platform will be selected (such as x86).

The following applications will be considered in last waves (Wave-X) for each country. They will be further reviewed and discussed with customers because some of them may not be able to relocate due to country specific policies and regulations.

To better manage and standardize the wave plan, the Wave-X is divided into multiple sub-waves and multiple consultation teams to determine the possibility or way of migration.

Table 5-4 Wave-X Application Selection Principles (Wave-XX-X):

Item	Description
Wave X-a	<ul style="list-style-type: none">• Applications that have core-network connections where the migration may need to change the telecom network configuration.• Applications that have special network interface cards which cannot be easily removed.
Wave X-b	<ul style="list-style-type: none">• Applications that have legal issues in movement to other country. Further review is needed at the Detailed Design stage.
Wave X-c	Services and technologies related: <ul style="list-style-type: none">• Applications that provide revenue-generated services to the national subscribers in the country.• Applications that are used to delivery services to the subscribers who are sensitive to the bandwidth. Bandwidth degradation will impact the SLA of the subscribers.• Applications that need to be reminded.

5.4.2 Assumptions

Wave Design:

- Huawei assumes that the hardware and software readiness before each individual wave started. Before that, planning with hardware and software vendors is expected to take place earlier.
- Application adaptation will be handled differently by different vendors. The effort spent on activities such as testing and deployment will rely on the application complexity. For example, for a highly complex application such as billing system or an application that has multiple interconnections with different applications and external partners, the application vendor will require months of porting / testing effort. However, due to limited information provided in the RFP, Huawei is unable to estimate the effort required for all applications. It is assumed that all application vendors will be alert at least 3 months earlier than the wave starts, so that they should have time to perform their application adaptation and testing.
- After the Discovery and Analysis phase, it is assumed that the wave design and plan will be frozen. If there are any changes, the change management procedure will be applied, and the changes will be determined and aligned at the detailed planning stage of each sub-wave.

IT Infrastructure

- As software components (operating system and database) will remain in their current versions to minimize the impact on Application Adaptation, the related hardware which is compatible with the software component will be provided by customers.
- The IT management system being used in current data center can be used for performance and SLA monitoring during the transaction.

5.5 Implementation

The objective of Migration Execution is to achieve a target state that meets the requirements while minimizing business impact. Huawei will apply its PMO methodology to manage the logical data migration as well as perform the logical data migration tasks and activities. This includes managing the designated customer resources, running the command center, managing the detailed tasks (from the detailed migration plan) and managing communications with stakeholders during the migration event.

5.5.1 Planning Service

Migration Planning

Huawei provides the most comprehensive transformation and migration planning solution in the market. In kinds of complex IT environment, Huawei can provide the analysis to ensure that your movement is made faster, with less risk and cost. Huawei not only provides you with detailed information regarding infrastructure requirements, but also provides detailed placement and guest sizing information so the resulting environment is optimized from every perspective.

Major migration planning is described as follows:

- Plan movement groups or waves to ensure migration is executed with a view to application dependencies.
- Qualify and profile workload candidates to determine the proper migration to the cloud.
- Normalization of workloads leveraging benchmarks for accurate analysis.
- Size workloads and assessing workload history, patterns and profiles.
- Investigating opportunities across multiple hardware brands or even platform architectures.
- Determining precise infrastructure requirements to avoid over-provisioning.
- Analyze power consumption and potential savings.
- Policy modeling, such as SLA requirements, privacy, security, DR, HA policies, regulations, and utilization limits.
- Determine the best match with suitable environments, cloud instance sizes and software stacks based on existing configurations, migration policies and costs.
- Exception handling for workloads that are not suitable for migration or do not match standard cloud offerings.
- Determine specific workload placement and resource allocation requirements.
- Enable automatic placement through the generation of machine-readable extracts that feed provisioning tools.

Risk Mitigation Plan

- Matrix of identified risks, symptoms, and impacts associated with migration efforts, prioritized based on the associated impact
- Scheduling analysis including conflicts at the application and application group level along with resolution options
- Risk Mitigation Options ranked by Risk Factor and associated impact
- Network and application vulnerability assessment and remediation reports

Runbook Validation and Contingency Planning

Huawei will develop Runbooks and contingency plans. The scope of this step is to validate the completeness and effectiveness of the Runbooks, ensure all parties agree and understand their roles, hand offs, and then verify that the contingency plans are sufficient in scope and detail, and agreed with all parties.

5.5.2 Migration Service

Storage Migration

Storage Migration Strategy

The data migration strategy includes:

- Identifying data to be migrated
- Determining timing of data migration
- Generating data templates
- Freezing tools for data migration
- Deciding on migration related setups
- Deciding on data archiving.

The UNIX based host treats the storage unit as one or more generic disk drives. The following methods can be used to migrate data from one storage to another.

- Hardware LUN copy and migration
- Application migration tools
- Host volume management

Solution 1: Data Migration (Storage)

Hardware (Storage Array) LUN migrates (Remote Copy) the data from the source Storage Arrays to the destination Storage Arrays.

Solution 2: Data Migration (Application Tools)

The data migration solution that is based on Application Data Migration, such as Oracle ASM, moves data from the source storage array to destination storage arrays.

Solution 3: Data Migration (Host Volume Manager)

The data migration solution that is based on HOST MultiPath and volume function, such as HP PV-Link / Secure Path, moves data from the source SAN storage array to destination SAN storage arrays.

Solution 4: Data Migration (Migration Tools)

The data migration solution that is based on VIS 6000.

DB Migration

Database migration is to migrate a complete database system from one environment to another. The database migration is designed from four perspectives: data integrity, data accuracy, rollback capability, and maximum downtime.

Huawei can provide Oracle migration.

Oracle

Two modes of the Oracle database migration are supported: logic (import/export) and live migration. They are applicable to dedicated scenarios. This section describes the four migration modes and provides guidance for users to choose the most appropriate database migration mode.

- Oracle off-line Migration

The Oracle off-line migration is to perform the backup on the original database server, transmit the backup files to the target server, and restore the database on the target server.

The database objects such as users, tables, and storage procedures are exported from the original database using the EXPDP tool. Their backup files are imported to the target database by way of the IMPDP tool.

- Oracle Live Migration

The live migration is to migrate data to the target database, almost without interrupting the original database server. Golden Gate offers data synchronization functionality. The principle of live migration is to transmit log files from the original database to the target database, apply these log files on the target database, and synchronize the target database with the original database.

- Conclusion

After the preceding analysis, it is recommended to:

- Use the off-line migration mode if the original and target databases are heterogeneous and the data scale is small.
- Use the live migration (Golden Gate) mode, if the database has higher requirement of downtime.

X86 Server Migration

P2P

The full name of P2P is physical to physical. It is a method to migrate system from one physical computer to another same physical computer or even to a different physical computer. To restore system to a dissimilar hardware configure or a bare machine will be an easy task. P2P will help you:

- Migrate to different hardware with minimal effort
- Upgrade hardware while keeping all programs and settings intact
- Replace failed hardware and cannot find an exact match for original system specification

P2V

Physical to Virtual (P2V) refers to the migration or conversion of a physical machine's operating system, and its applications, or data from a physical computer to a virtual machine.

The success of each P2V conversion is based on how dozens of tasks and details are handled. Pre-conversion planning and preparation as well as post-conversion testing are vital. Some solutions do not automate any of these important (and time-consuming) functions and focus solely on the actual physical-to-virtual data conversion, while others provide much more coverage and automation of the overall process.

- Network virtualization: In network virtualization, virtual switch, VLAN and port group isolate VMs from different services or users. VM's vNICs are one-to-one correspondence with the physical server physical NIC.

- **Computing virtualization:** Computing nodes provide the computing resource for VMs running on it that includes vCPU, vRAM and vNIC. Determine VM specifications (vCPU, vRAM, virtual Disk, and vNIC) based on current applications and performance data.
- **Storage:** Convert source physical server's physical disk partition to virtual disk partition.

The time taken for the actual conversion and copying of the machine depends on network speeds as well as on the underlying processing speed of the P2V conversion tool. Some tools are designed from the ground up to optimize conversion efficiencies.

The complexity of preparation and of conversion itself creates opportunities for error, so newly converted VMs must be tested to ensure that the conversion was successful. Even when conversion is completely successful, there are several post-conversion tasks that must be completed, either manually or by automation.

V2V

This chapter describes the migration details and selected approach for V2V. It gives guidelines for how to precede, dependent on the platform that the system is on today. If the virtualization platform of To-Be is the same with As-Is, transporting the virtualization platform management data and VM files to To-Be virtualization platform, else using V2V convertor tool converting the VM virtual disk to the format of target virtualization platform.

V2V migrations are generally less complicated than virtualized physical servers (or P2V migrations). Unlike physical servers, virtual servers are not configured with a wide range of hardware devices; therefore, there are fewer problematic hardware dependencies.

It is important to understand the performance requirements of the VM prior to the migration.

A resource assessment of the source VMs is an important step in the process to ensure Project success. Understanding requirements (such as, RAM, disk, network connection, and CPU capacity) up front will save time and effort later.

The next step involves the identification and assessment of all virtual servers to be migrated. The targeted VMs need to be monitored and analyzed for their use of CPU, memory, disk, and networking resources. Both the average and peak levels of usage should be measured and tracked. The results of this analysis will be used in architecting the new virtualization infrastructure and in determining the optimal distribution of VMs across the cluster of hypervisor server hosts. Because of the lack of standardization for the virtual disk format and content, there is no true portability for VMs across different hypervisor hosts. VMs must be converted into the native format of the target hypervisor during the V2V migration.

5.5.3 Process

Huawei migration process is based on the results of analysis and assessment.

Step 1 Infrastructure Readiness Planning

The objective of this step is to ensure the readiness of the infrastructure encompassing all aspects of the move of customer services to the new data centers.

Step 2 Dress Rehearsal Planning and Execution

Step 3 Final Migration Execution

5.5.4 Tools

The following table will show us most of the tools during migration

Type	Tools	Usage
Server Migration	X86 virtualization capacity and planning tool	Capacity and planning
	DC Rainbow	P2V/V2V Migration
	Double take	P2P Migration
Database Migration	Oracle DB capacity and planning tool	Capacity and planning
	Oracle Golden Gate	Oracle Migration
	Oracle EXPDP/IMPDP	Oracle Migration
Storage Migration	ASM	Oracle RAW Device Migration
	volume manager	Storage Migration
	lun copy	Storage Migration
	VIS 6000	Storage Migration

5.5.5 Temporary Infrastructure

In order to ensure the transformation success, temporary infrastructure including tools are used.

5.6 Verification and Validation

Huawei will verify and validate the migration for the business system. Verification is intended to check that a product, service, or system (or portion thereof, or set thereof) meets a set of initial design specifications. In the migration phase, verification procedures involve performing special tests to model or simulate a portion, or the entirety, of a product, service or system, then performing a review or analysis of the modeling results. In the post-migration phase, verification procedures involve regularly repeating tests devised specifically to ensure that the product, service, or system continues to meet the initial design requirements, specifications, and regulations as time progresses. It is a process that is used to evaluate whether a product, service, or system complies with regulations, specifications, or conditions imposed at the start of a development phase. Verification can be in development, scale-up, or production. This is often an internal process.

Validation is categorized by the following functions:

- Prospective validation
- Retrospective validation
- Full-scale validation
- Partial validation
- Cross-validation
- Re-validation/Locational or periodical validation

- Concurrent validation

5.7 Deliverables

- Design service deliverables
 - Capacity Design
 - Assets Reuse Design
 - Migration Plan
 - Risk Migration Management Plan
 - Runbook Validation and Contingency Planning
- Implementation design
 - Migration high-level design
 - Migration low-level design
- Migration process

6 Benefits

Meeting Growing Business Needs

- Shorten the time of getting IT resources that new business needs from several months to a few days or even hours
- Provide high availability and flexibility for applications through cloud computing without additional hardware investments.
- Improve the customer satisfaction by meeting the main business IT requests through the resources sharing that the cloud data center provides.

Optimizing Operation Costs

- After reducing the data center brands and platforms, the management cost can be reduced up to 60%
- After reducing the number of data centers and increasing the IT equipment utilization, the electrical energy can be reduced by 20% to 50%

Reducing the IT Operation and Maintenance Risk

- Reduce the operation and maintenance risk by centralizing supervision and management through data centers.
- Debase the management complexity
- Increase the business SLA
- Predictable capacity planning

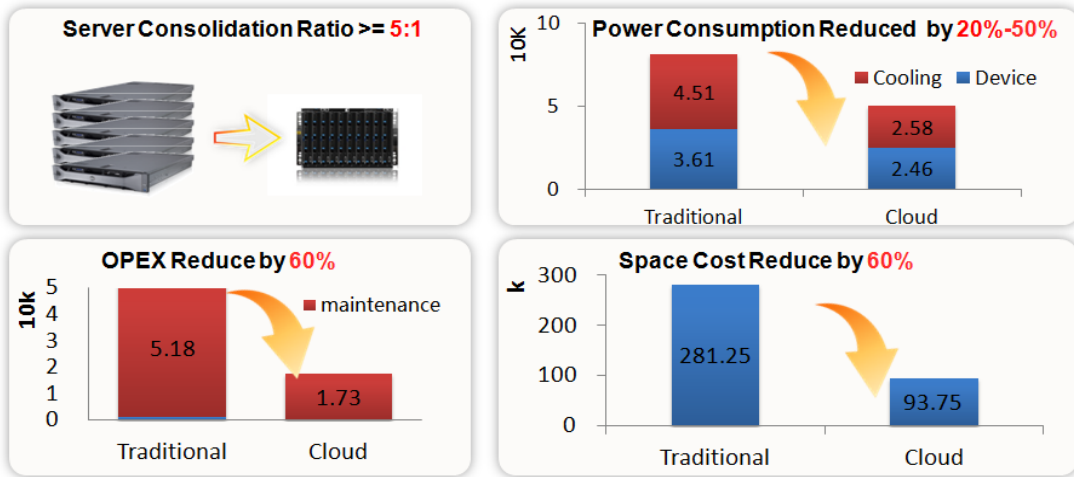

7 Conclusion

Based on rich experiences, Huawei DC Transformation and Migration service provides professional methodology, process, tool and team to help DC assessment and migrate current data center to new data center. The service includes migration planning, migration tools, migration implementation and test. Huawei DC Transformation Planning Service provides migration planning service after the analysis process. The migration planning service helps customers design the migration solution, detailed implementation process and migration assurance plans. This migration process provides professional migration service for DC managers to migrate the AS-IS data center to TO-BE data center.

8 Why Huawei

8.1 Professional Service

Huawei rich and professional experience in migration helps implement more than 120 projects, including many national DC migration.

- Professional Teams
Largest business migration team in China, over 200 experts in 12 domains (such as security, storage, and facilities) certified by the PMP, CISSP, CISP, CISA, and CCIE.
- Professional Tools
Huawei is proficient in more than 20 migration tools and can provide second-based solution.
- Professional Process
Huawei can provide perfect migration process including safe and fast support tools.
- Qualifications
Huawei has qualifications in ISO27001, ISO9001, ISO20000, and CIMM-5.

8.2 End to End Solution

Huawei provides better services with flexible E2E solutions, not only in the technical domain but also in the commercial domain, such as financing, industry value chain collaboration. Huawei aims to provide a one-stop-shop to satisfy all of your network & IT operation needs.



8.3 Global Delivery

Huawei has significant global resources and footprints. For example, Huawei has 12,000 software R&D and delivery resources for BSS/OSS projects around the world and have both a on- off-shore strategy to support your business. Huawei has more than 12 R&D and customization centers across Nigeria, South Africa, Saudi Arabia, Pakistan, India, Thailand, Shenzhen, Indonesia, Mexico, Brazil, Iran, and Turkey.

- 120+ customers from 12 industries include government, telecom, finance... ;
- Total migration servers/hosts reached 82K;
- Migration data up to 1,800T with zero data loss and 100% satisfaction;

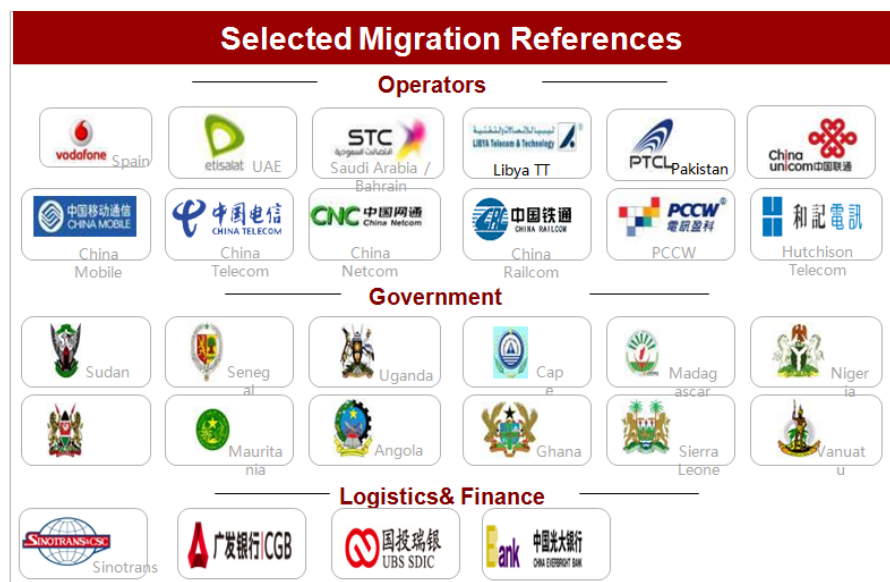

Huawei has rich DC transformation delivery experience all over the world.

8.4 Successful Story

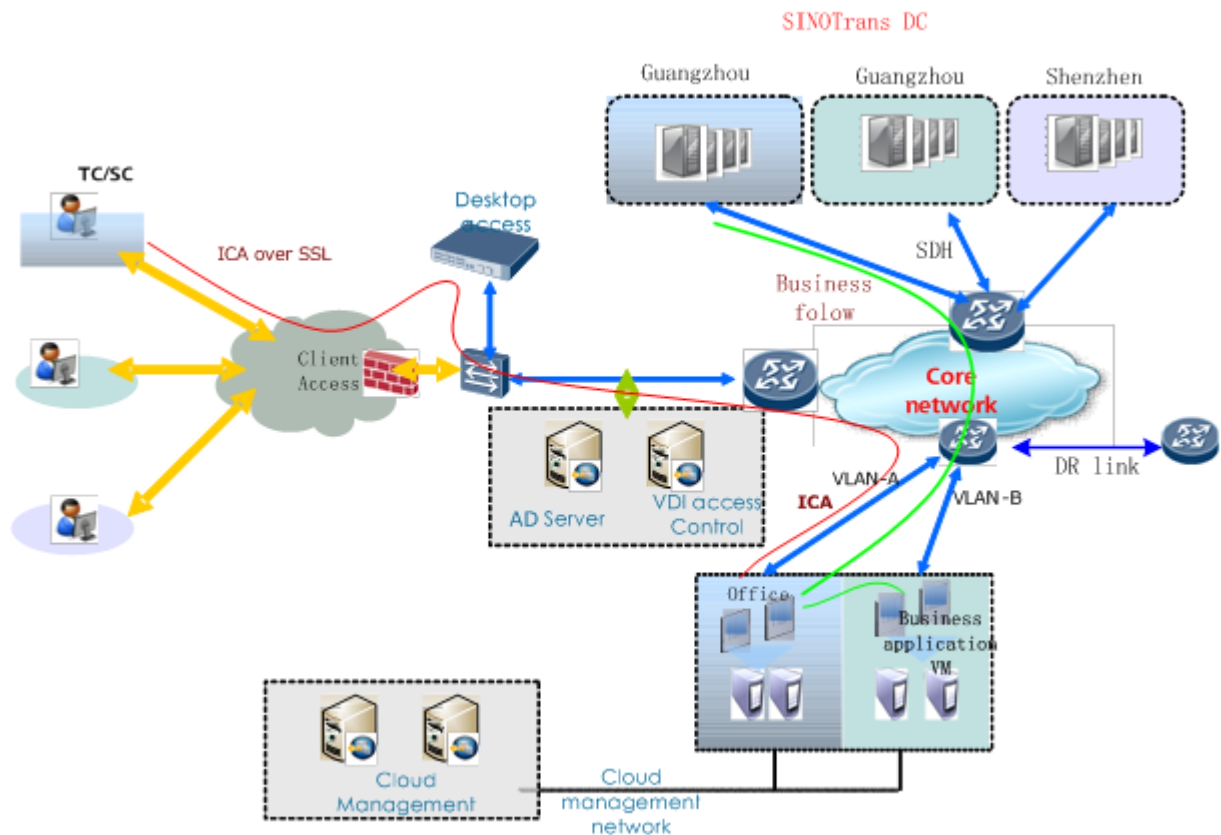

Challenges

- Increased IT investment
- Unreliable service systems
- Poor office environment
- Long service rollout period

Benefits

- Reduce facility and maintenance investment by 30%
- Provide a 99.99% SLA service, on-demand payment
- IT management standardization and normalization

Solution

- Migrate 48 service systems to the cloud platform and consolidates 200 servers.
- Support the operation of over 40 SINOTRANS branches with cloud-based services.
- Perform disaster recovery and data backup for 60% of the basic resources in two Guangzhou data centers, and backs up the key data in the Shenzhen data center.